

Light efficiency:



Output: 692 lm

Light quality:



Peak: 1863 cd

Power: 15.0 W



Beam angle

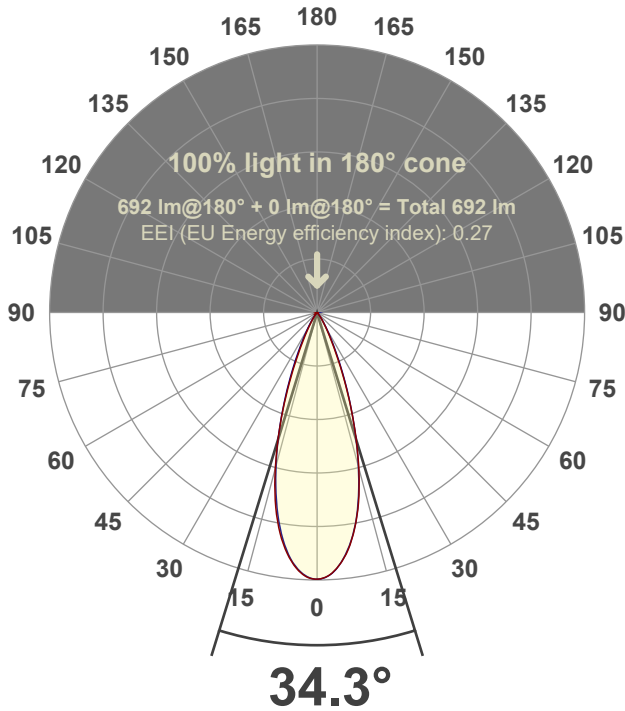

Test number:

GR-F-F-A14-2722-FL-RD-91A-Rev2

Luminaire Model:

Graffiti Flat Round Fixed Downlight-A14-2722 38° Optic-Solite

Date and time:

3/24/2022 7:08:24 PM

Delivered Lumens

692

Spectra

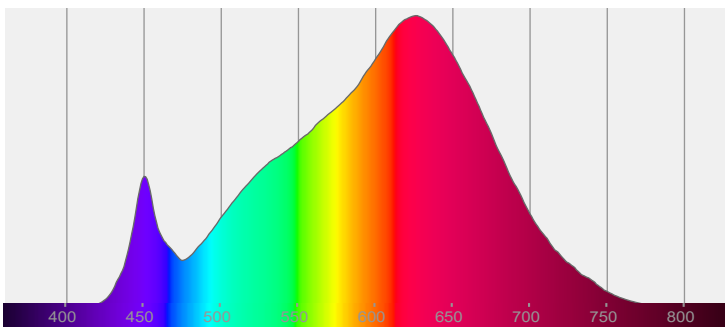

CRI: 94.8 (R1-R8)

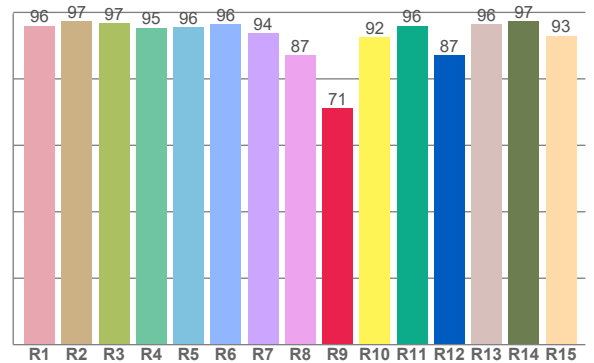

Color parameters

	Color rendering index	Red component	Color fidelity	Color gamut	Color quality scale	Color coordinate cie 1931	Color coordinate cie 1931	Color coordinate	Color coordinate	Color deviation from black body
	CRI	CRI R9	TM30 R _f	TM30 R _g	CQS	x	y	u	v	Δuv
	94.8	71.1	92.6	101.9	91.4	0.447	0.402	0.258	0.348	-0.0020

R_f 92.6
Fidelity index R_f

R_g 101.9
Gammut index R_g

TM30: 92.6

TM-30Color

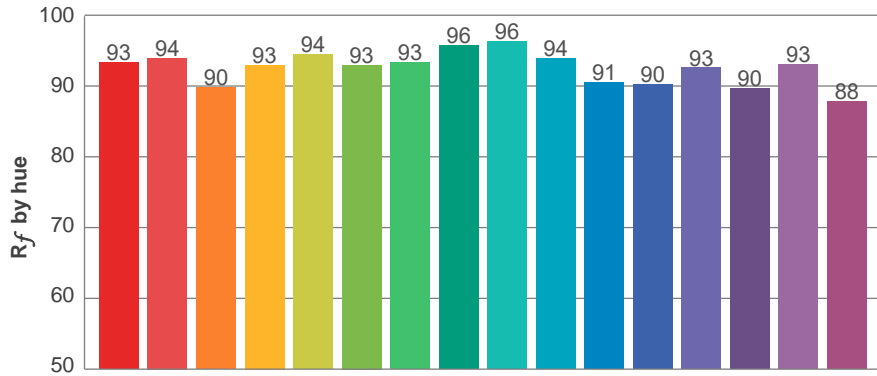

Hue Bin	R_f	Graphic shifts (%)	
		Chroma	Hue
1	93	-4%	-1%
2	94	-2%	2%
3	90	0%	5%
4	93	1%	3%
5	94	3%	3%
6	93	5%	0%
7	93	1%	-4%
8	96	1%	-3%
9	96	-1%	0%
10	94	-2%	3%
11	91	1%	7%
12	90	5%	2%
13	93	4%	-3%
14	90	5%	-7%
15	93	1%	-4%
16	88	-1%	-10%

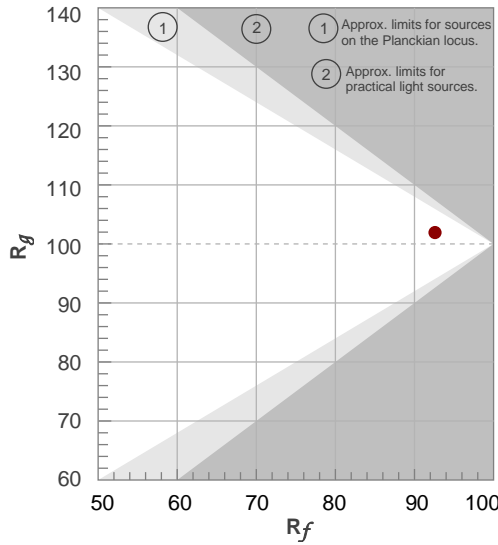

Color vector graphics

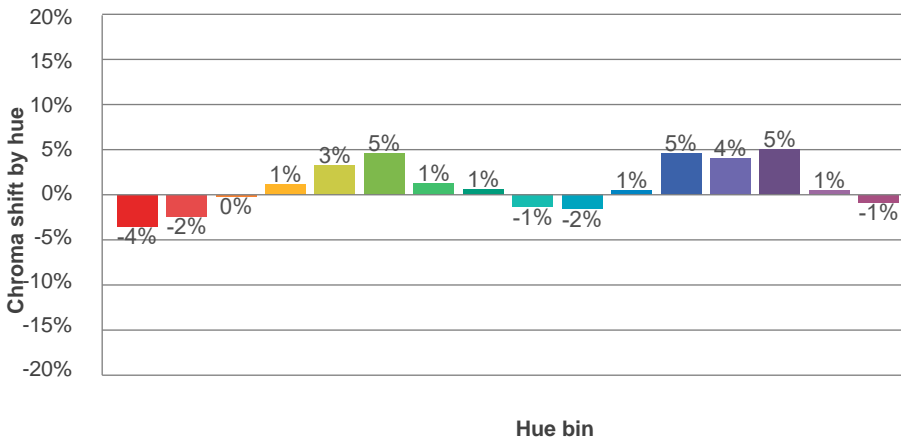
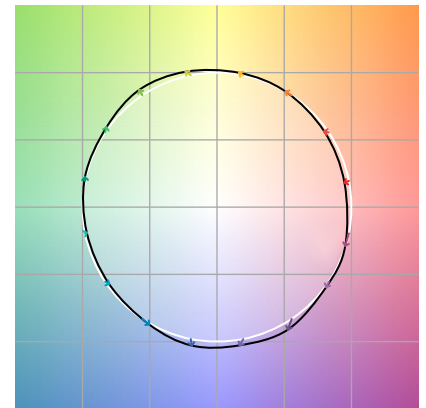

Color distortion

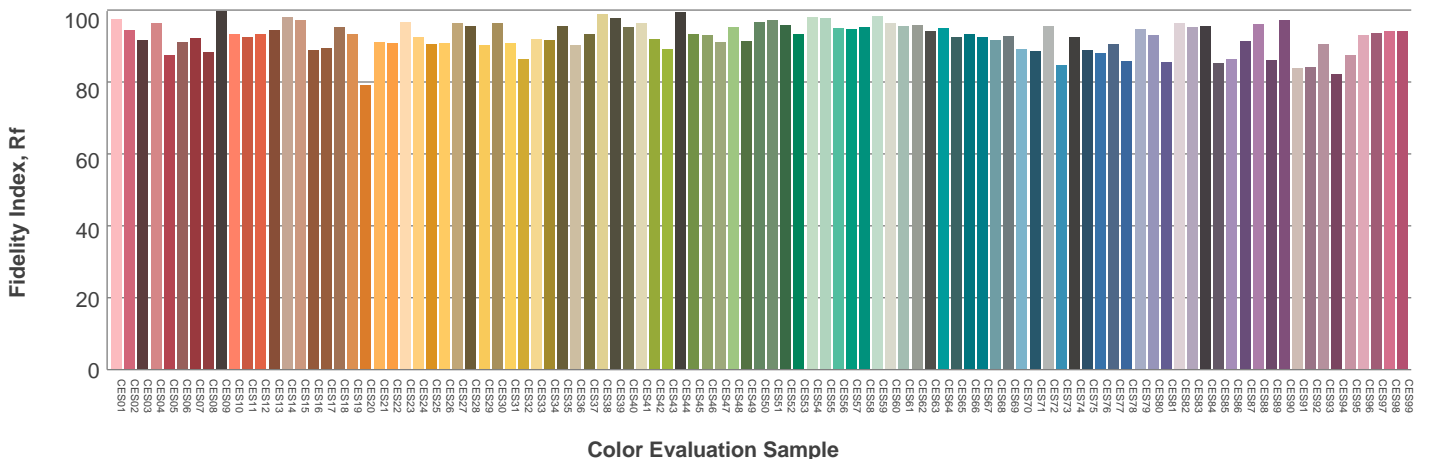
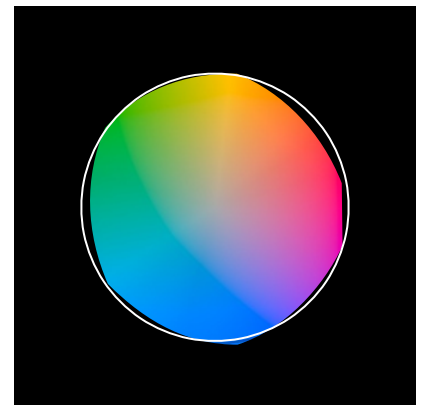

Beam details

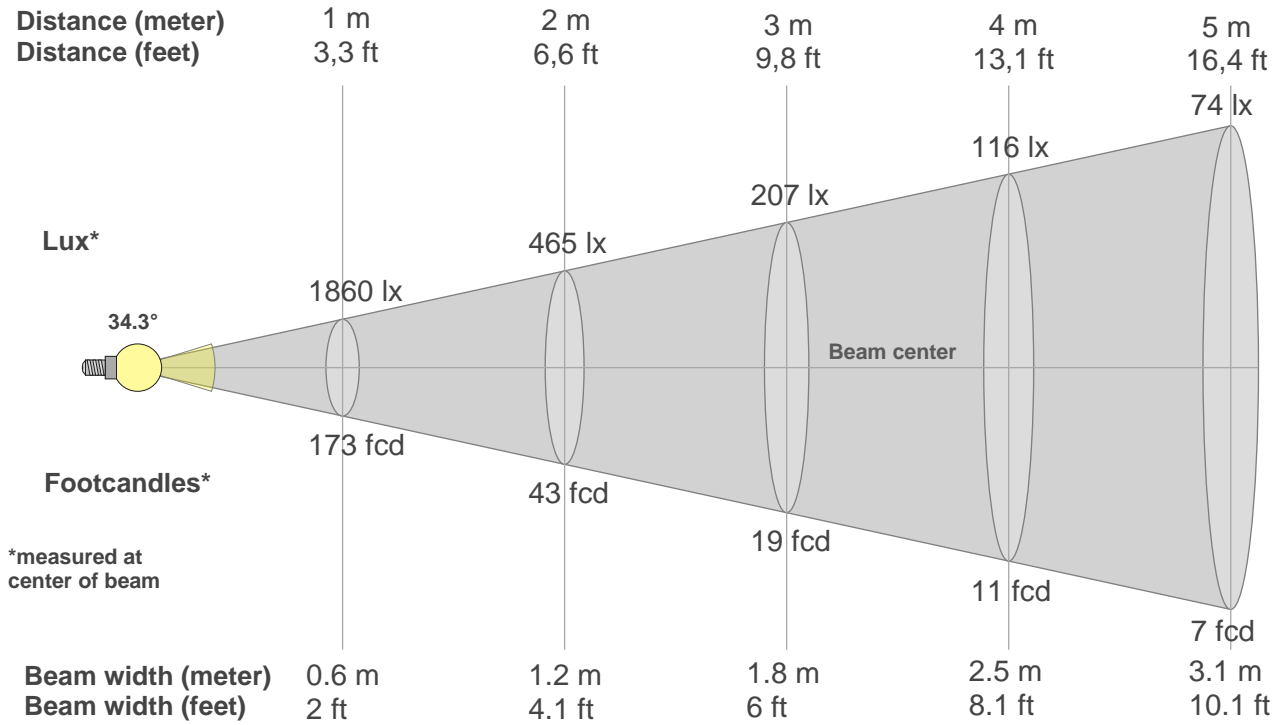

Beam intensities from 1-20m

1m	2m	3m	4m	5m	6m	7m	8m	9m	10m	11m	12m	13m	14m	15m	16m	17m	18m	19m	20m
3.3ft	6.6ft	9.8ft	13.1ft	16.4ft	19.7ft	23ft	26.2ft	29.5ft	32.8ft	36.1ft	39.4ft	42.7ft	45.9ft	49.2ft	52.5ft	55.8ft	59.1ft	62.3ft	65.6ft
1860lx	465lx	207lx	116lx	74lx	52lx	38lx	29lx	23lx	19lx	15lx	13lx	11lx	9lx	8lx	7lx	6lx	6lx	5lx	5lx
172.8fcd	43.2fcd	19.2fcd	10.8fcd	6.9fcd	4.8fcd	3.5fcd	2.7fcd	2.1fcd	1.7fcd	1.4fcd	1.2fcd	1fcd	0.9fcd	0.8fcd	0.7fcd	0.6fcd	0.5fcd	0.5fcd	0.4fcd

Intensities in 0° c-plane

0°	2°	4°	6°	8°	10°	12°	14°	16°	18°	20°	22°	24°	26°	28°	30°	32°	34°	36°	38°
1860	1845	1800	1732	1641	1524	1382	1216	1037	854	676	513	375	270	194	140	102	75	57	43
100%	99%	97%	93%	88%	82%	74%	65%	56%	46%	36%	28%	20%	15%	10%	8%	5%	4%	3%	2%

Intensities in 90° c-plane

0°	2°	4°	6°	8°	10°	12°	14°	16°	18°	20°	22°	24°	26°	28°	30°	32°	34°	36°	38°
1860	1844	1803	1733	1636	1516	1371	1206	1029	849	681	529	398	291	209	152	110	79	56	40
100%	99%	97%	93%	88%	81%	74%	65%	55%	46%	37%	28%	21%	16%	11%	8%	6%	4%	3%	2%

Intensities in 180° c-plane

0°	2°	4°	6°	8°	10°	12°	14°	16°	18°	20°	22°	24°	26°	28°	30°	32°	34°	36°	38°
1860	1851	1808	1739	1648	1532	1392	1222	1038	852	671	503	359	254	179	125	88	63	47	34
100%	100%	97%	94%	89%	82%	75%	66%	56%	46%	36%	27%	19%	14%	10%	7%	5%	3%	3%	2%

Intensities in 270° c-plane

0°	2°	4°	6°	8°	10°	12°	14°	16°	18°	20°	22°	24°	26°	28°	30°	32°	34°	36°	38°
1860	1845	1804	1736	1634	1508	1361	1198	1025	852	685	532	400	291	208	150	108	77	55	40
100%	99%	97%	93%	88%	81%	73%	64%	55%	46%	37%	29%	22%	16%	11%	8%	6%	4%	3%	2%

Beam angle 50%	Field angle 10%	Cutoff angle 2,5%	Intensity ratio in 120° cone	Intensity ratio in 90° cone
34.3°	56.8°	73.8°	98.2%	96.7%

LAMPS (number of lamps)
50

Light planning Luminaire budgetary diagram

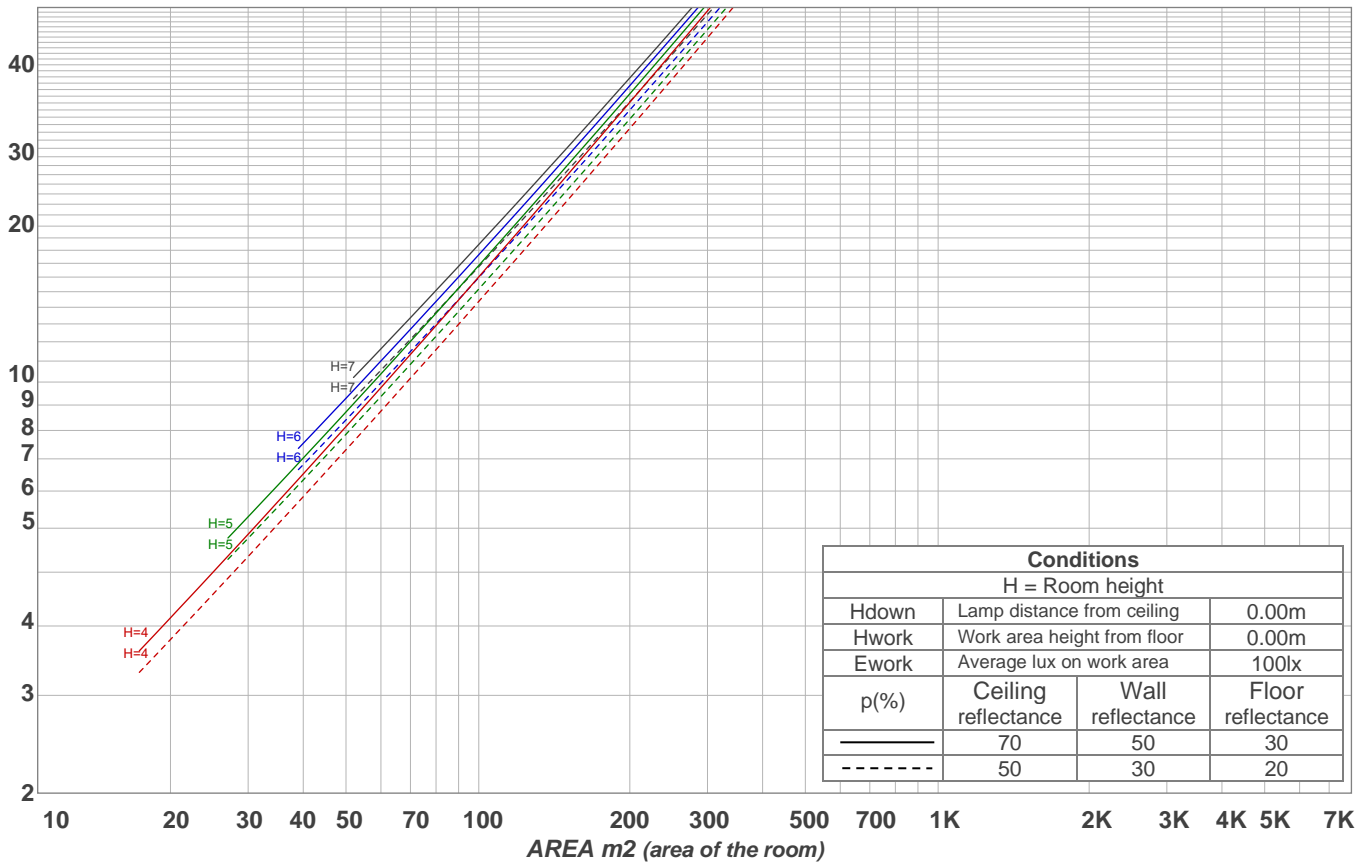

Luminaire budgetary diagram AREA m2 (area of the room) Coefficients of Utilization

Ceiling reflectance	80				70				50			30			10			0			
Wall reflectance	70	50	30	10	70	50	30	10	50	30	10	50	30	10	50	30	10	50	30	10	0
Floor reflectance	20	20	20	20	20	20	20	20	20	20	20	20	20	20	20	20	20	20	20	20	0
RCR	(RCR: Room Cavity Ratio)																				
	Room Values are expressed as percentage of Lumens delivered to the task surface																				
0	119	119	119	119	116	116	116	116	111	111	111	106	106	106	102	102	102	100	100	100	
1	114	112	110	108	112	110	108	106	106	104	103	102	101	100	98	98	97	95	95	95	
2	110	105	102	99	108	104	101	98	101	98	96	98	96	94	95	93	92	90	90	90	
3	105	100	96	92	104	99	95	92	96	93	90	94	91	89	92	89	88	86	86	86	
4	101	95	91	87	100	94	90	87	92	88	86	90	87	85	88	86	84	82	82	82	
5	98	91	86	83	96	90	86	82	88	84	82	87	83	81	85	82	80	79	79	79	
6	94	87	82	79	93	86	82	78	85	81	78	84	80	77	82	79	77	76	76	76	
7	91	83	79	75	90	83	78	75	82	78	75	81	77	74	80	76	74	73	73	73	
8	88	80	75	72	87	80	75	72	79	75	72	78	74	71	77	74	71	70	70	70	
9	85	77	72	69	84	77	72	69	76	72	69	75	71	69	74	71	68	67	67	67	
10	82	74	70	67	81	74	70	67	73	69	66	73	69	66	72	69	66	65	65	65	

Zonal Lumen Summary

0°-10°	10°-20°	20°-30°	30°-40°	40°-50°	50°-60°	60°-70°	70°-80°	80°-90°
161 lm	303 lm	156 lm	42.4 lm	11.5 lm	5.92 lm	5.25 lm	4.39 lm	2.72 lm
90°-100°	100°-110°	110°-120°	120°-130°	130°-140°	140°-150°	150°-160°	160°-170°	170°-180°
0.000 lm	0.000 lm	0.000 lm	0.000 lm	0.000 lm	0.000 lm	0.000 lm	0.000 lm	0.000 lm