

GRAFFITI™

GR-M Series

Project Name:

Specifier:

Distributor:

Quantity:

Type:

Signature:

GRAFFITI™

is the innovative new line of MR-16 lighting solutions from Specialty Lighting Industries.



GRM Series in low to medium ceiling heights typically found in residential, commercial or retail applications. GR-M series fixtures feature a standard regress surface that blends seamlessly with the ceiling construction. The Graffiti™ fixtures provide cost effective MR-16 lighting solutions. As the creative spirit of its name implies, Graffiti™ systems provide all the quality SLI has grown famous for over the last 25 years, but at reduced lead times, affordable price points and innovative technologies that will liberate your creative flair.

ADJUSTABLE / FIXED SPECIFICATIONS

MOUNTING - Recessed in architectural ceiling. Butterfly brackets and Hanger bars included with housing and mounting pans.

- **IC**-Housing for new construction where insulation comes in contact with fixture
- **NIC**-Housing for new construction where IC not required
- **IH**- International Housing (Open Housing- no transformer included)
- **AH**- Airtight Housing (Non IC)

TRIM - One piece die cast aluminum, flanged or flangeless trim with a flat surface . Available for wet locations.

Accommodates up to 1" ceiling thickness as standard.

- **ZT/ZST**- for use in plaster/GWB ceilings
- **FT/FST**- for use in architectural ceilings

ELECTRICAL

- **Magnetic (TX)**
- **Electronic SORAA (EXS)** Powered by SORAA

LAMP



- **MR16**- 50W Max. (37W Max for IC/Airtight) , Available as GU10
- **SMRA**- Sorra Retrofit

LENS/OPTICS - Interchangeable reflector provides multiple beam patterns. Field-changeable optics

- Optional lenses available for aperture include Solite and Veiling Acrylic. Accepts two optical accessories and an optional trim mounted lens.

FINISH - Black powder paint housing. Aper. trim available in white as standard. Can be field painted to match ceiling finish.

WARRANTY - 2 year limited on MR-16 and transformer. See website for details.

LABELS -  US, US tested to UL standards 1598, Dry/Damp and Wet listings. IC/Airtight, 

ACCESSORY - 1287 Hanger Bar comes standard with IC/NIC Housing*

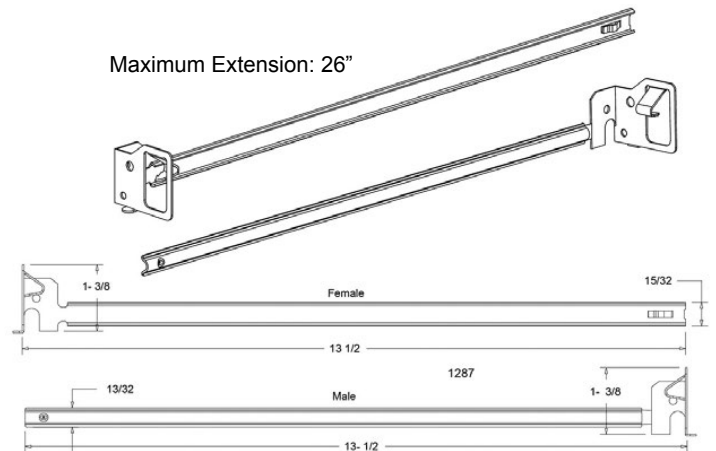

Patent Pending. These specifications subject to change without notice. 11/16

INFORMATION- TRIM

ROUND / FLANGED



ROUND / FLANGELESS

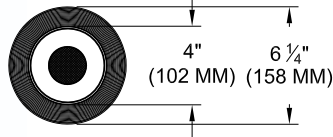

SQUARE / FLANGED

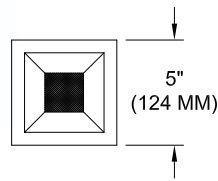

SQUARE / FLANGELESS

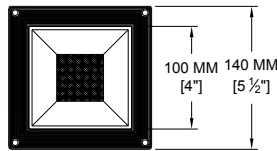

INFORMATION- HOUSING

For easy installation in existing ceilings.

IH- International use only

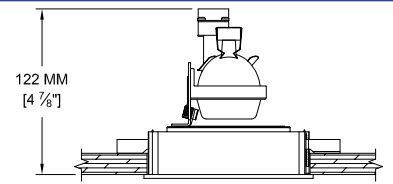
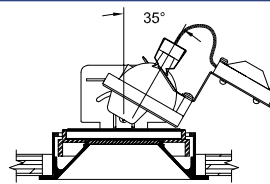
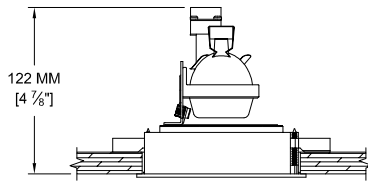
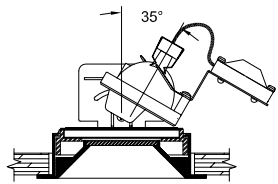
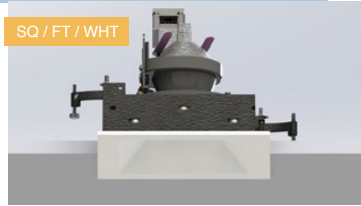

*For projects requiring housings or IC rated fixtures.

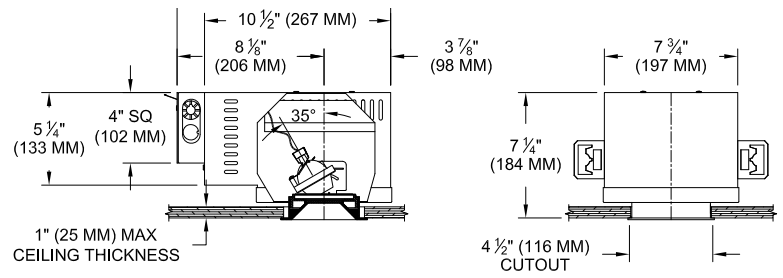
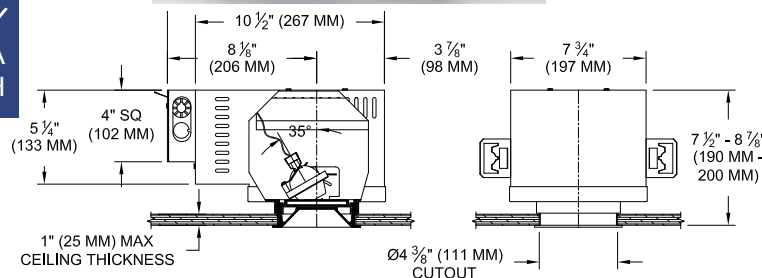
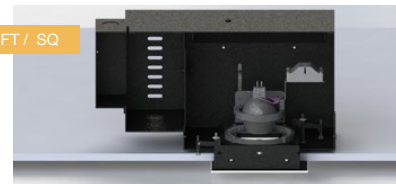
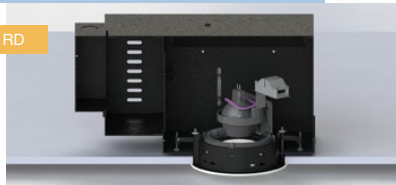

ORDER INFO

CODE

Graffiti™ Housing

GR-M

Housing

IC = IC
 NIC = Non IC
 IH = International Housing (Open Housing- no transformer included)
 AH = Airtight Housing (Non IC)

Source/Wattage/Lumens/Delivered

MR37 = MR-16 / 37W Max for IC/Airtight
 MR50 = MR-16 / 50W
 GUMR = MR-16 GU10
 SMRA = SORAA Retrofit

Type

F = Fixed
 A = Adjustable

Transformer

TX = Magnetic
 EXS = Electronic SORAA
 GX = GU10 Socket*

*GU10 requires 120V

Voltage

120V
 277V

Graffiti™ Trim

GRT-M

Shape

RD = Round
 SQ = Square

Trim

FT = Flanged
 ZT = Flangeless
 FST* = Flanged Shower
 ZST* = Flangeless Shower

*Lens Required

Finish

WHT

WHT = White

Lens

91A = Solite

* CLICK HERE to view Accessories for Trims.

I
C
N
I
C
/A
H

