



GRW-M Series



is the innovative new line of MR-16 lighting solutions from Specialty Lighting Industries.



GRWM

Series in low to medium ceiling heights typically found in residential, commercial or retail applications. GRW-M series fixtures feature a recessed conical trim that provide directional fixed lighting to walls. The Graffiti™ fixtures provide cost effective MR-16 lighting solutions. As the creative spirit of its name implies, Graffiti™ systems provide all the quality SLI has grown famous for over the last 25 years, but at reduced lead times, affordable price points and innovative technologies that will liberate your creative flair.

Project Name:

Specifier:

Distributor:

Quantity:

Type:

Signature:

WALL WASH

SPECIFICATIONS

MOUNTING - Recessed in architectural ceiling. Butterfly brackets and Hanger bars included with housing and mounting pans.

- **IC**-Housing for new construction where insulation comes in contact with fixture
- **NIC**-Housing for new construction where IC not required
- **IH**- International Housing (Open Housing- no transformer included)
- **AH**- Airtight Housing (Non IC)

TRIM - One piece die cast aluminum, flanged or flangeless trim with a regressed surface . Available for wet locations. Accommodates up to 1" ceiling thickness as standard.

- **ZT/ZST**- for use in plaster/GWB ceilings
- **FT/FST**- for use in architectural ceilings

ELECTRICAL

- **Magnetic (TX)**
- **Electronic SORAA (EXS)** Powered by SORAA



LAMP

- **MR16**- 50W Max. (37W Max for IC/Airtight)
- **SMRA**- Sorra Retrofit

LENS/OPTICS - Supertex borosilicate spread lens, hinged for relamping. Alzak kick reflector.

FINISH - Black powder paint housing. Aper. trim available in white as standard. Can be field painted to match ceiling finish.

WARRANTY - 2 year limited on MR-16 and transformer. See website for details.

LABELS -  US, US tested to UL standards 1598, Dry/Damp and Wet listings. IC/Airtight,  compliant, 

ACCESSORY - 1287 Hanger Bar comes standard with IC/NIC Housing*

Maximum Extension: 26"

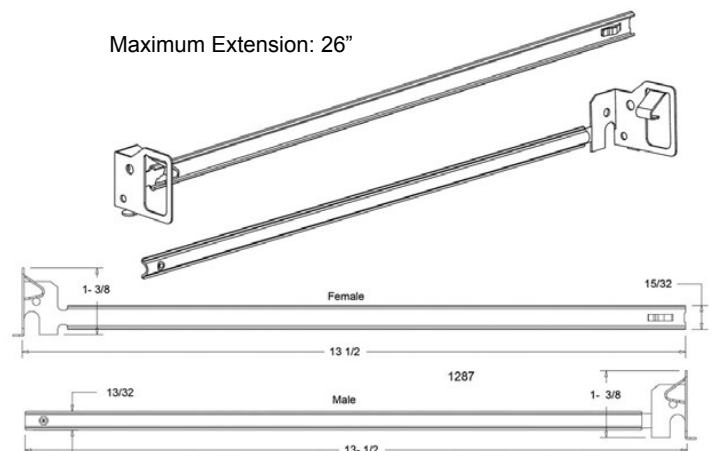

Patent Pending. These specifications subject to change without notice. 7/18

INFORMATION- TRIM



ROUND/ FLANGED

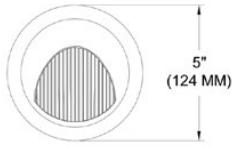

ROUND / FLANGELESS

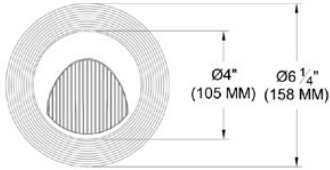

SQUARE / FLANGED

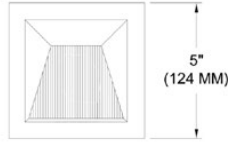

SQUARE / FLANGELESS

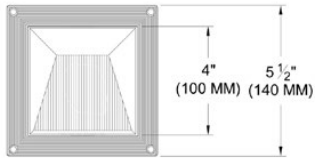

INFORMATION- HOUSING

For easy installation in existing ceilings.

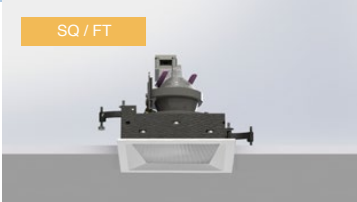

SQ / FT



RD / ZT

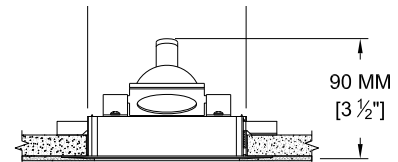
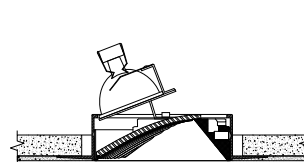
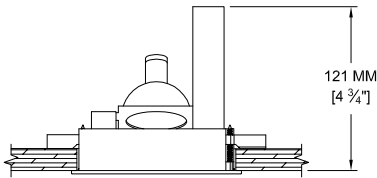
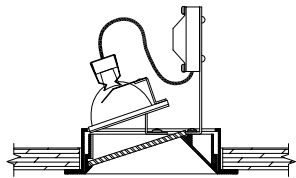

*For projects requiring housings or IC rated fixtures. IC housings will have no vents.



NIC / FT / RD

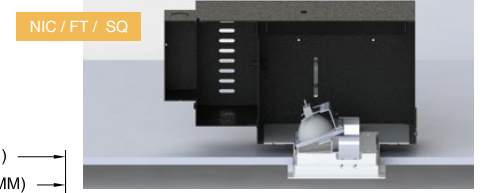

NIC / FT / SQ

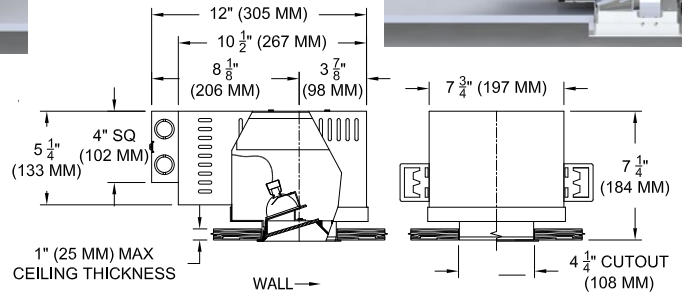
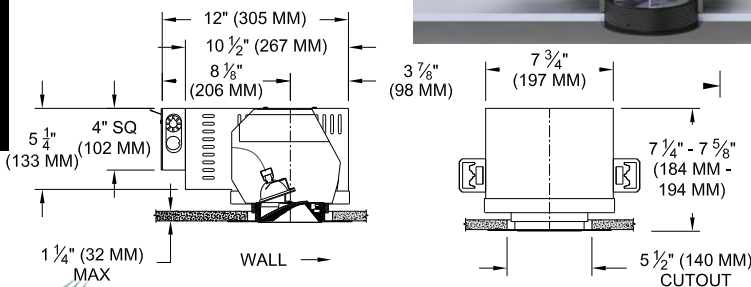

Patent Pending. These specifications subject to change without notice. 7/18

ORDER INFO

CODE

Graffiti™ Housing

GRW-M

Housing

- TITLE 24 IC = IC
- NIC = Non IC
- IH = International Housing (Open Housing- no transformer included)
- AH = Airtight Housing (Non IC)

Source/Wattage/Lumens/Delivered

- MR37 = MR-16 / 37W Max for IC/Airtight
- MR50 = MR-16 / 50W

- TITLE 24 SMRA = SORAA Retrofit

Type

WW = Wall Wash

Transformer

- TX = Magnetic
- EXS= Electronic SORAA

Voltage

- 120V
- 277V

Graffiti™ Trim

GRWT-M

Shape

- RD = Round
- SQ = Square

Trim

- FT = Flanged
- ZT = Flangeless
- FST* = Flanged Shower
- ZST* = Flangeless Shower

*Lens Required

Finish

WHT

WHT = White

Lens

82A = Frosted Supertex

* CLICK HERE to view Accessories for Trims.

I
H

I
C
N
C
/A
H