

Light efficiency:



Light quality:



Color temperature:

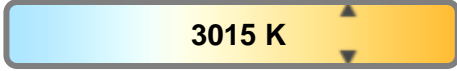

Output: 1119 lm

Peak: 2581 cd

Power: 20.6 W

PF: 0.98

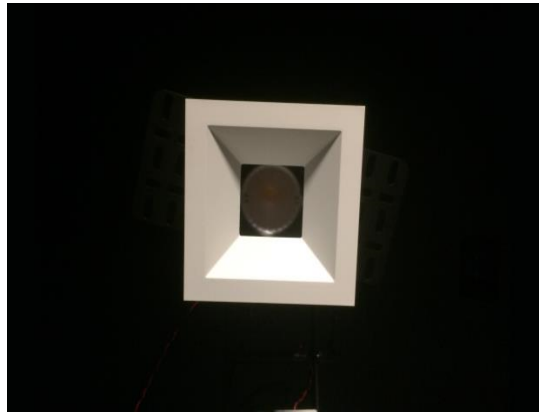

Beam angle

38.4°

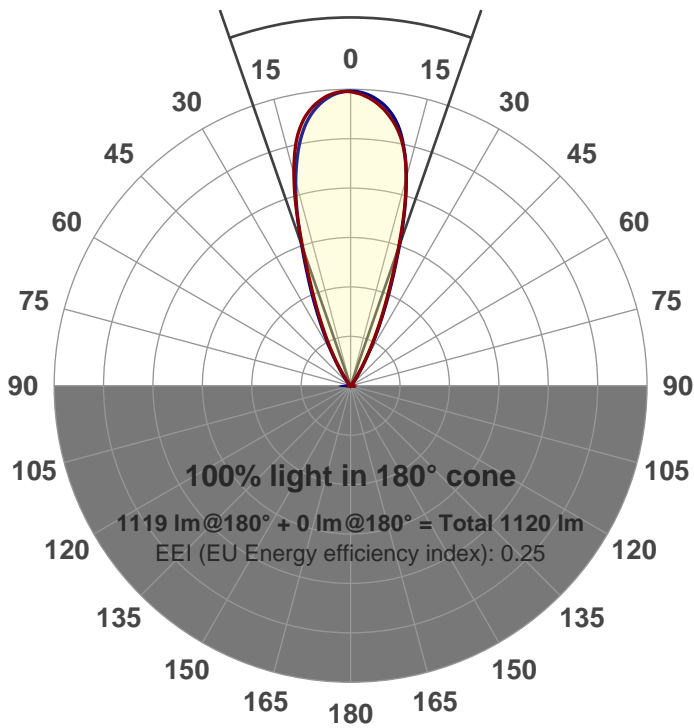

Product name:

GR-XT3017-FL-SQ-91A

Item number:

GR-XT3017-FL-SQ-91A

Date and time:

7/5/2017 12:44:53 PM

Description:

LUM: 1119

PPF: 22.2



CIE 1931

x: 0.434

y: 0.400

Spectra

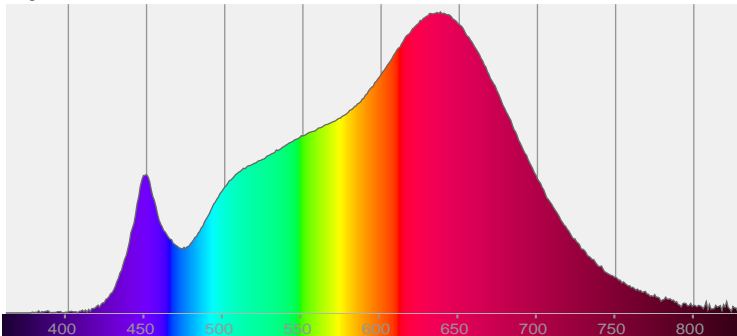

Power

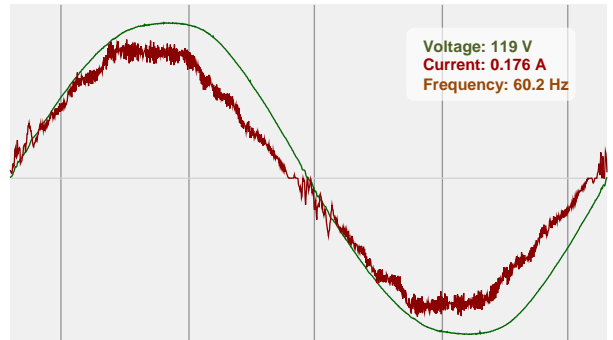

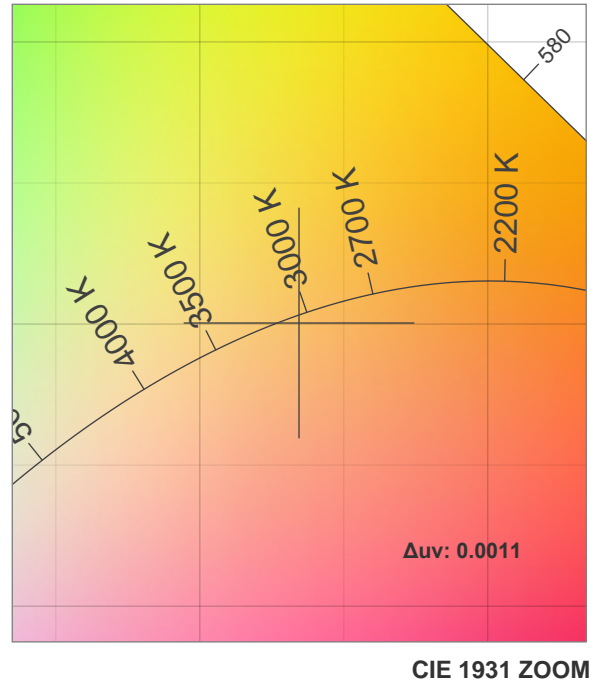
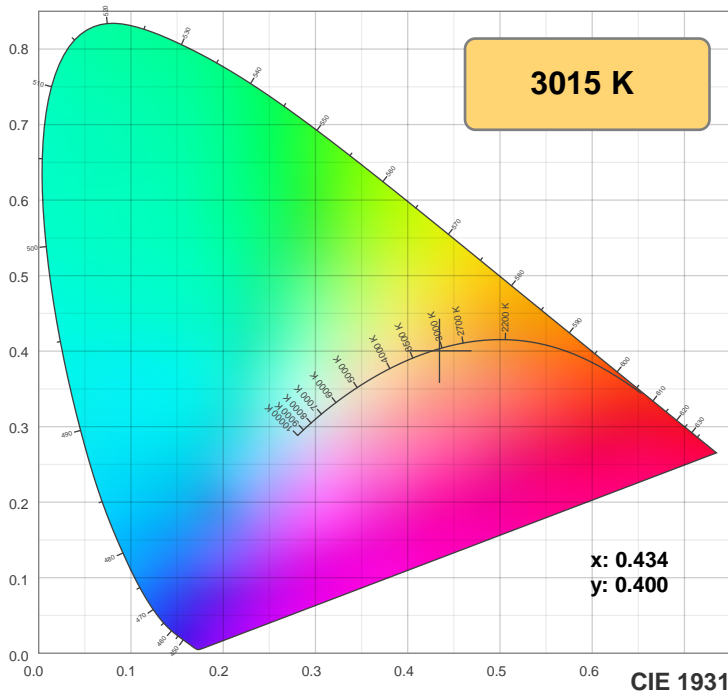

TM30: 96.0

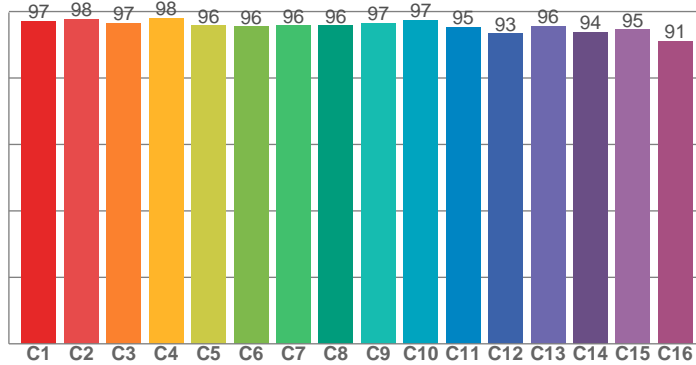

CRI: 97.4 (R1-R8)

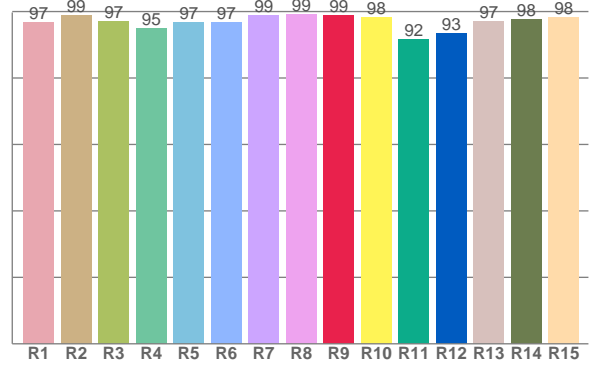

CRI R values, only R1-R8 are used to calculate final CRI value

R1	R2	R3	R4	R5	R6	R7	R8	R9	R10	R11	R12	R13	R14	R15
96.9	98.9	97.2	95.1	96.8	96.8	98.9	99.1	98.8	98.4	91.7	93.3	97.1	97.6	98.1

TM30 C values, 16 binned values out of total of 99 C values

C1	C2	C3	C4	C5	C6	C7	C8	C9	C10	C11	C12	C13	C14	C15	C16
97.2	97.8	96.6	98.1	95.9	95.5	95.8	95.8	96.5	97.4	95.4	93.5	95.6	93.9	94.6	91.2

CQS Q values

Q1	Q2	Q3	Q4	Q5	Q6	Q7	Q8	Q9	Q10	Q11	Q12	Q13	Q14	Q15
97.2	97.6	95.1	98.0	95.3	93.4	95.7	98.4	97.8	98.0	97.4	96.9	97.3	96.9	97.5

CQS: 96.4

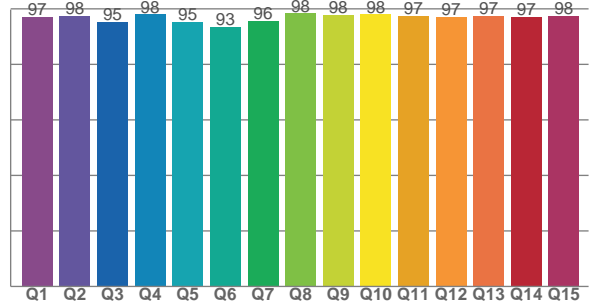

Color parameters

Color temperature	Color rendering index	Red component	Color fidelity	Color gamut	Color quality scale	Color coordinate cie 1931	Color coordinate cie 1931	Color coordinate	Color coordinate	Color diviation from black body
CCT	CRI	CRI R9	TM30 Rf	TM30 Rg	CQS	x	y	u	v	Δuv
3015 K	97.4	98.8	96.0	102.6	96.4	0.434	0.400	0.251	0.346	0.0011

TM30 details

Rf 96.0
Fidelity index Rf

Rg 102.6
Gammut index Rg

Hue Bin	R _f	Graphic shifts (%)	
		Chroma	Hue
1	97	0%	-1%
2	98	0%	0%
3	97	1%	0%
4	98	0%	0%
5	96	-1%	1%
6	96	2%	1%
7	96	1%	0%
8	96	2%	0%
9	97	1%	0%
10	97	1%	0%
11	95	2%	2%
12	93	3%	0%
13	96	2%	-2%
14	94	3%	-3%
15	95	1%	-2%
16	91	3%	-6%

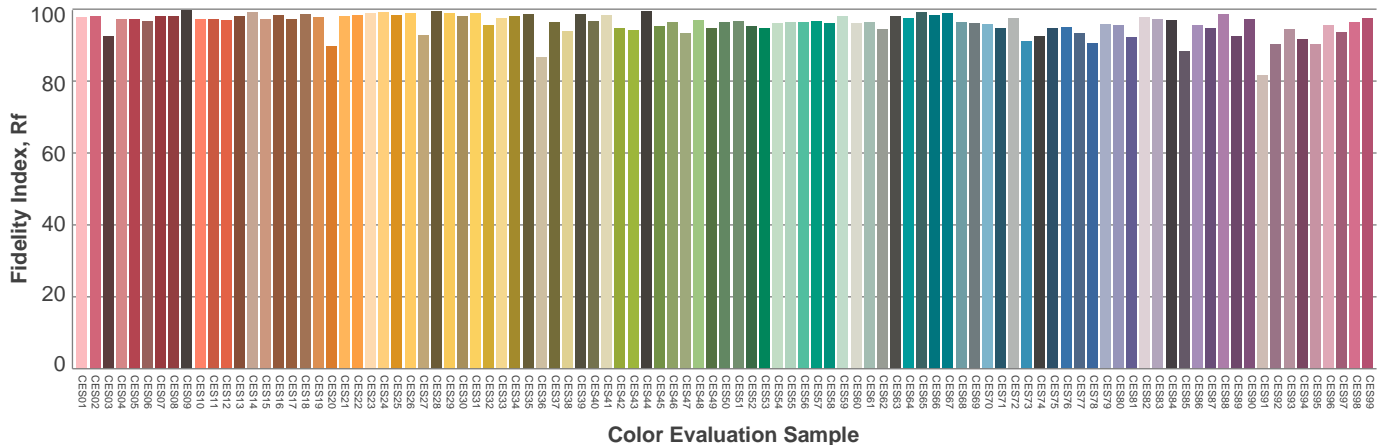
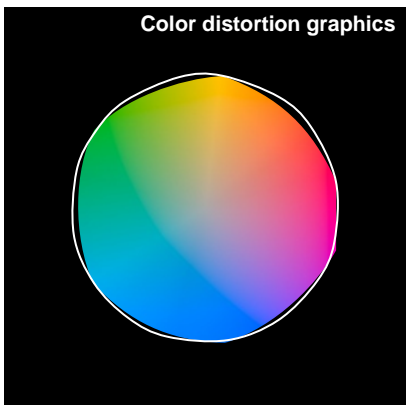
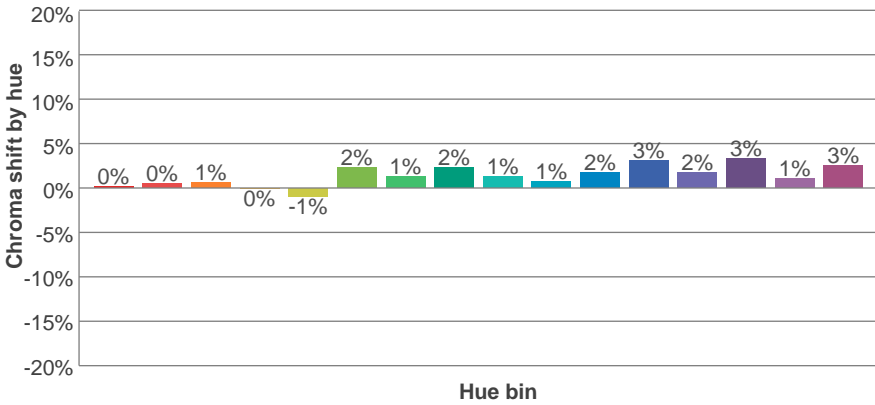
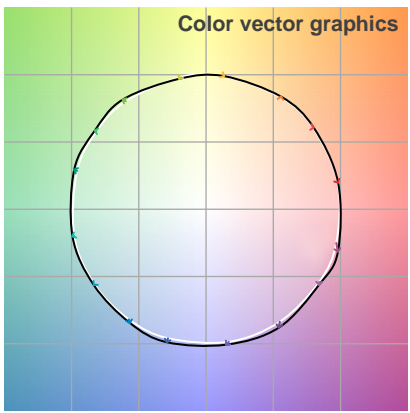
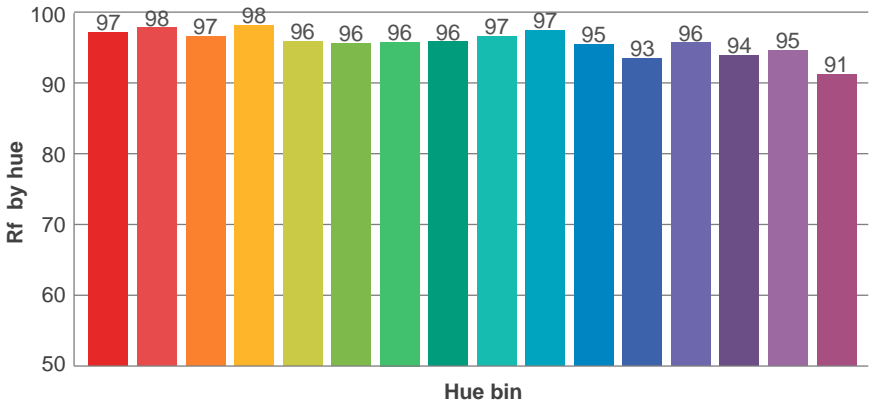
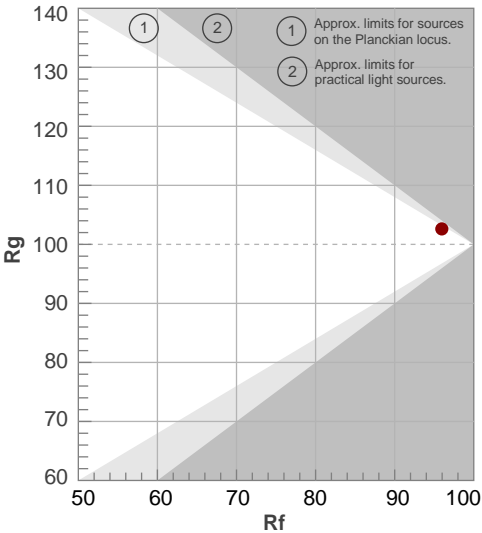

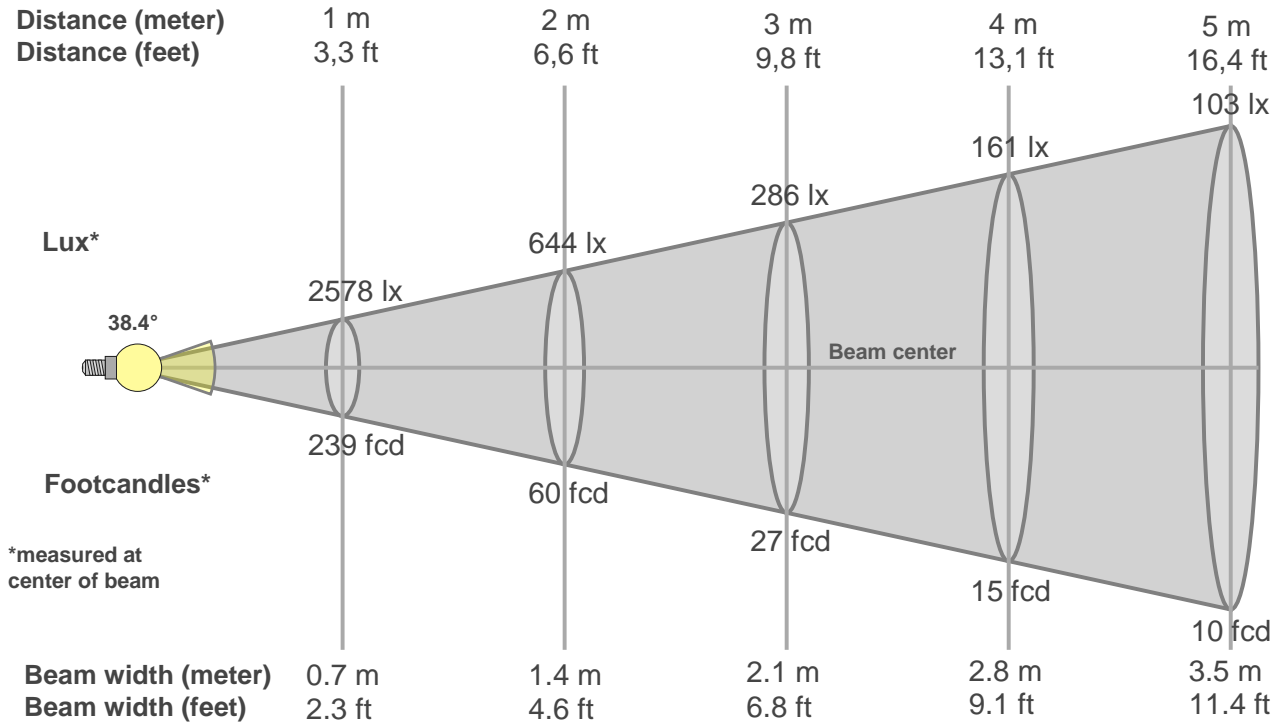

Beam intensities from 1-20m

1m	2m	3m	4m	5m	6m	7m	8m	9m	10m	11m	12m	13m	14m	15m	16m	17m	18m	19m	20m
3.3ft	6.6ft	9.8ft	13.1ft	16.4ft	19.7ft	23ft	26.2ft	29.5ft	32.8ft	36.1ft	39.4ft	42.7ft	45.9ft	49.2ft	52.5ft	55.8ft	59.1ft	62.3ft	65.6ft
2578lx	644lx	286lx	161lx	103lx	72lx	53lx	40lx	32lx	26lx	21lx	18lx	15lx	13lx	11lx	10lx	9lx	8lx	7lx	6lx
239.5fcd	59.9fcd	26.6fcd	15fcd	9.6fcd	6.7fcd	4.9fcd	3.7fcd	3fcd	2.4fcd	2fcd	1.7fcd	1.4fcd	1.2fcd	1.1fcd	0.9fcd	0.8fcd	0.7fcd	0.7fcd	0.6fcd

Intensities in 0° c-plane

0°	2°	4°	6°	8°	10°	12°	14°	16°	18°	20°	22°	24°	26°	28°	30°	32°	34°	36°	38°
2578	2575	2556	2516	2455	2367	2236	2040	1781	1466	1151	899	697	531	395	280	185	114	65	37
100%	100%	99%	98%	95%	92%	87%	79%	69%	57%	45%	35%	27%	21%	15%	11%	7%	4%	3%	1%

Intensities in 90° c-plane

0°	2°	4°	6°	8°	10°	12°	14°	16°	18°	20°	22°	24°	26°	28°	30°	32°	34°	36°	38°
2578	2570	2540	2489	2413	2308	2159	1967	1738	1468	1193	957	754	580	432	311	217	145	95	62
100%	100%	99%	97%	94%	90%	84%	76%	67%	57%	46%	37%	29%	22%	17%	12%	8%	6%	4%	2%

Intensities in 180° c-plane

0°	2°	4°	6°	8°	10°	12°	14°	16°	18°	20°	22°	24°	26°	28°	30°	32°	34°	36°	38°
2578	2555	2518	2465	2393	2302	2176	1995	1750	1457	1153	892	684	510	366	248	157	93	55	35
100%	99%	98%	96%	93%	89%	84%	77%	68%	57%	45%	35%	27%	20%	14%	10%	6%	4%	2%	1%

Intensities in 270° c-plane

0°	2°	4°	6°	8°	10°	12°	14°	16°	18°	20°	22°	24°	26°	28°	30°	32°	34°	36°	38°
2578	2571	2545	2499	2433	2337	2190	1999	1757	1480	1186	935	720	539	385	263	175	113	75	50
100%	100%	99%	97%	94%	91%	85%	78%	68%	57%	46%	36%	28%	21%	15%	10%	7%	4%	3%	2%

Beam angle 50%	Field angle 10%	Cutoff angle 2,5%	Intensity ratio in 120° cone	Intensity ratio in 90° cone
38.4°	60.7°	73°	1.0%	1.0%

THIS PAGE INTENSIONALLY LEFT BLANK